



OHC COVID-19 Antigen Self Test Health Care Provider Instructions for Use (IFU)

For *In vitro* diagnostic use only
For use under an Emergency Use Authorization (EUA) Only.
For use with anterior nasal swabs specimens

Table of Contents

1.	INTENDED USE	3
2.	EXPLANATION OF THE TEST.....	4
3.	MATERIALS PROVIDED	4
4.	MATERIALS REQUIRED BUT NOT PROVIDED.....	4
5.	QUALITY CONTROL	4
6.	PREPARE TO PERFORM THE TEST.....	4
7.	TEST PROCEDURES.....	5
8.	INTERPRETATION OF THE RESULTS.....	7
9.	STORAGE AND STABILITY.....	8
10.	WARNINGS & PRECAUTIONS.....	9
11.	LIMITATIONS.....	10
12.	PERFORMANCE CHARACTERISTICS.....	11
13.	CLINICAL EVALUATION	14
14.	TECHNICAL SUPPORT	16
15.	ORDERING AND CONTACT INFORMATION	16
16.	INTERNATIONAL SYMBOL USAGE.....	16

1. INTENDED USE

The OHC COVID-19 Antigen Self Test is a lateral flow immunoassay intended for the qualitative detection of nucleocapsid protein antigen from SARS-CoV-2. The test is authorized for non-prescription home use with self-collected anterior nasal (nares) swabs from individuals aged 14 years and older when tested twice over three days with at least 24 hours (and no more than 48 hours) between tests. The test is authorized for individuals aged 14 years and older with symptoms of COVID-19 within the first 7 days of symptom onset, or individuals without symptoms or other epidemiological reasons to suspect COVID-19.

This test is also authorized for non-prescription home use with adult-collected anterior nasal (nares) swab specimens from individuals aged 2 years and older when tested twice over three days with at least 24 hours (and no more than 48 hours) between tests. The test is authorized for individuals aged 2 years and older with symptoms of COVID-19 within the first 7 days of symptom onset, or individuals without symptoms or other epidemiological reasons to suspect COVID-19.

The OHC COVID-19 Antigen Self Test does not differentiate between SARS-CoV or SARS-CoV-2 viruses.

Results are for the identification of SARS-CoV-2 nucleocapsid protein antigen. Antigen is generally detectable in anterior nasal (nares) swabs during the acute phase of infection. Positive results indicate the presence of viral antigens, but clinical correlation with patient history and other diagnostic information is necessary to determine infection status. Positive results do not rule out bacterial infection or co-infection with other viruses. The agent detected may not be the definite cause of disease. Individuals who test positive with the OHC COVID-19 Antigen Self Test should self-isolate and seek follow up care with their physician or healthcare provider as additional confirmatory testing with a molecular test for positive results may also be necessary, if there is a low likelihood of COVID-19, such as in individuals without known exposures to COVID-19 or residing in communities with low prevalence of infection.

All negative results should be treated as presumptive and confirmation with a molecular assay may be necessary if there is a high likelihood of SARS-CoV-2 infection, such as in an individual with a close contact with COVID-19 or with suspected exposure to COVID-19 or in communities with high prevalence of infection. Negative results do not rule out SARS-CoV-2 infection and should not be used as the sole basis for treatment or patient management decisions, including infection control decisions. Negative results should be considered in the context of an individual's recent exposures, history, and the presence of clinical signs and symptoms consistent with COVID-19.

Individuals who test negative and continue to experience COVID-like symptoms of fever, cough and/or shortness of breath may still have SARS-CoV-2 infection and should seek follow up care from their healthcare provider.

Individuals should provide all results obtained with this product to their healthcare provider for public health reporting. All healthcare providers will report all test results they receive from individuals who use the authorized product to relevant public health authorities in accordance with local, state, and federal requirements, using appropriate LOINC and SNOMED codes, as defined by the Laboratory In Vitro Diagnostics (LIVD) Test Code Mapping for SARS-CoV-2 Tests provided by CDC.

The OHC COVID-19 Antigen Self Test is intended for non-prescription self-use and/or as applicable, for an adult lay user testing another aged 2 years or older. The OHC COVID-19 Antigen Self Test is only for use under the Food and Drug Administration's Emergency Use Authorization.

2. EXPLANATION OF THE TEST

COVID-19 (short for 'Coronavirus Disease 2019') is a disease first recognized in 2019 that is caused by a type of novel coronavirus called SARS-CoV-2. Due to its rapid spread, the World Health Organization (WHO) recognized the disease as a global pandemic on March 11, 2020. Individuals infected with SARS-CoV-2 may have a range of symptoms from asymptomatic infection to severe respiratory illness and even death. The virus is spread primarily from person to person through respiratory particles, even by individuals without symptoms.

The OHC COVID-19 Antigen Self Test is a rapid, qualitative immunochromatographic assay for the determination of the presence of SARS-CoV-2 antigens in self-collected anterior nasal swab specimens. The test strip is composed of the following parts: sample pad, reagent pad, reaction membrane, and absorbing pad. The reagent pad contains the colloidal-gold conjugated with the monoclonal antibodies against the nucleocapsid protein of SARS-CoV-2; the reaction membrane contains the secondary antibodies for nucleocapsid protein of SARS-CoV-2. The whole strip is fixed inside a plastic device. When the sample is added into the sample well, conjugates dried in the reagent pad are dissolved and migrate along with the sample. If SARS-CoV-2 nucleocapsid antigen is present in the sample, a complex forms between the anti-SARS-2 conjugate and the virus will be captured by the specific anti-SARS-CoV-2 monoclonal antibodies coated on the test line region (T).

The results of the test are interpreted at 15 minutes. Refer to the Interpretation of Results section.

3. MATERIALS AND REAGENTS PROVIDED

The OHC COVID-19 Antigen Self Test is offered in a 1, 2, 4, 5, and 25 test/kit sizes. The kit configurations are provided below:

Number of Test/Kit	1 Test/Kit	2 Tests/Kit	4 Tests/Kit	5 Tests/Kit	25 Tests/Kit
Test Cassette	1	2	4	5	25
Sterile Swab	1	2	4	5	25
Extraction Buffer Tube & Filter Cap	1	2	4	5	25
Instructions for Use	1	1	1	1	1

4. MATERIALS REQUIRED BUT NOT PROVIDED

- Timer

5. QUALITY CONTROL

Each OHC COVID-19 Antigen Self Test has a built-in internal procedural control. The pink/purple line appearing at the "C" position is an internal procedural control. This procedural control line indicates that sufficient flow has occurred, and the functional integrity of the test cassette has been maintained. A distinct pink/purple Control line should always appear if the test has been performed correctly. If the Control line does not appear, the test result is invalid, and a new test should be performed.

6. PREPARE TO PERFORM THE TEST

Step 1. Bring test kit to room temperature (59-86 °F /15-30°C).

NOTE: Blow your nose before washing your hands.

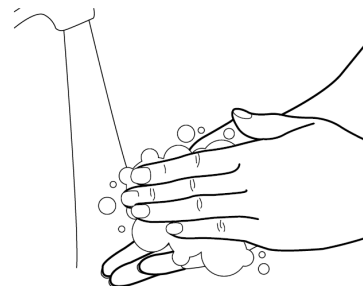

Step 2. Wash your hands with soap and water, or use hand sanitizer before performing the test. Make sure you rinse thoroughly and your hands are dry before starting.

Step 3. Check test expiry date on the back of the foil pouches. Do not use if the expiry date has passed.

NOTE: Testing should commence immediately after opening the sealed pouches.

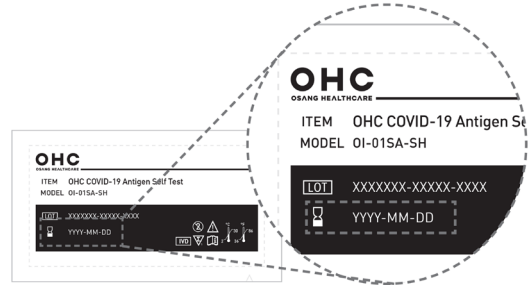

Step 4. Ensure that the test cassette is intact and that there are no green beads in the desiccant package (white and yellow beads are expected). Do not open the desiccant package.

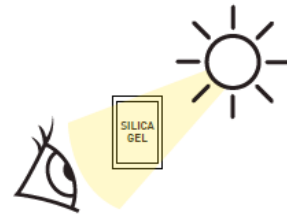

Step 5. Open Extraction buffer tube & Filter cap pouch By tearing along the tear-line. Remove the Extraction buffer tube & Filter cap.

7. TEST PROCEDURES

Step 1. OPEN TUBE

Remove the seal from the tube. Avoid spilling the liquid. Make sure the tube is standing up straight.

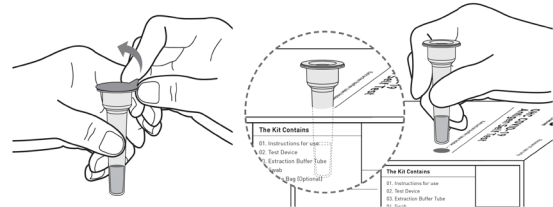

Step 2. PLACE TUBE IN TUBE HOLDER

Find tube holder shown on the front of the box. Push tube through outlined hole.

Step 3. OPEN SWAB

Open the swab pouch on the end opposite the swab tip by peeling back the pouch cover. Hold the plastic stick end of the swab and remove from pouch. Do NOT touch the swab end and only handle by the stick end.

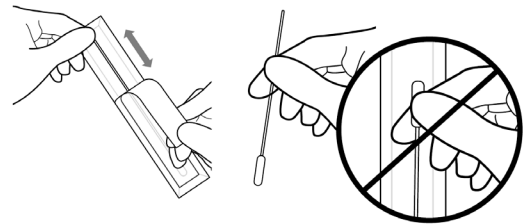

Step 4. SWAB BOTH NOSTRILS

Carefully insert swab tip into one nostril about 1/2 to 3/4 of an inch deep. Do not insert the swab any farther if you feel any resistance. Rub the insides of the nostril in a complete circle at least 5 times.

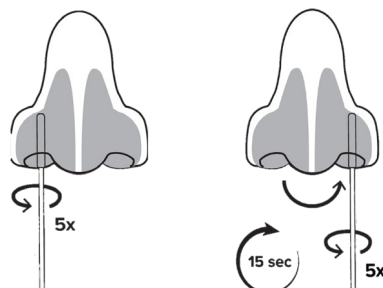

Make sure that you are rubbing the insides of the nostril. Do not simply roll the swab. Take approximately 15 seconds to collect the specimen. Be sure to collect any nasal drainage that may be present on the swab. Remove swab from the nostril and **repeat in your other nostril with the SAME swab.**

NOTE: If you are swabbing others, please wear a face mask. With children, the maximum depth of insertion into the nostril may be less than $\frac{3}{4}$ of an inch, and you may need to have a second person to hold the child's head while swabbing.

NOTE: Failure to swab properly may cause false negative results.

Step 5. **STIR THE SWAB IN THE TUBE**

Insert the swab into the tube until the soft pad is in the liquid. Squeeze the tube at the bottom and hold it tight. Then stir the swab **more than 10 times.**

This is to transfer the biological material from the swab to the liquid

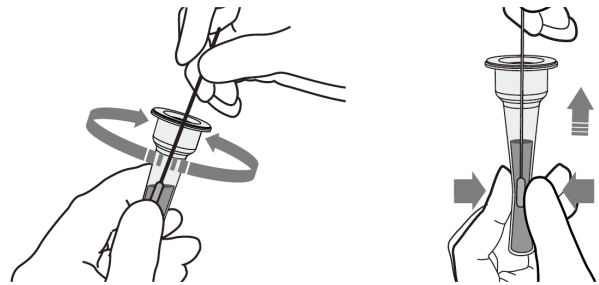

Step 6. **SQUEEZE THE TUBE**

Remove the swab while squeezing the sides of the tube to extract the liquid from the swab.

WARNING! Failure to squeeze the tube can lead to incorrect results due to excess buffer in the swab.

WARNING! The sample should be mixed into the buffer immediately, but no more than 1 hour after collecting the sample.

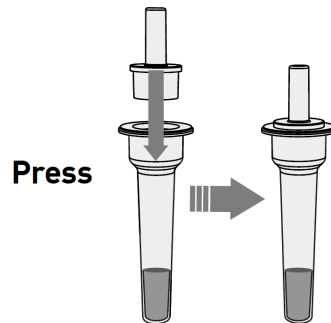

Step 7. **INSERT CAP**

Dispose of the swab and seal the tube securely with the filter cap.

NOTE: Ensure that the filter cap is securely fitted before proceeding to the next step

Step 8. **OPEN TEST CASSETTE**

Open the test cassette pouch by tearing along the tear-line. Place the test cassette on a flat surface.

Step 9. **ADD 4 DROPS**

Hold the tube straight up and down above the test cassette and gently squeeze to add **4 drops** of solution

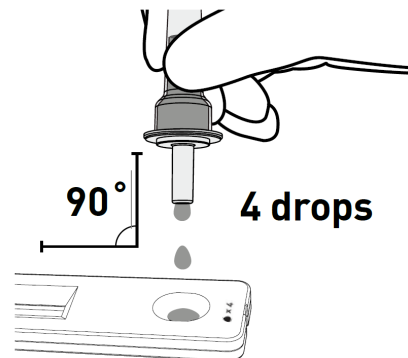

into the sample well, labeled as “● x 4” on the test cassette.

WARNING! Adding more or less than 4 drops of solution into the sample well may result in incorrect results.

Step 10. **START TIMER**

Start timer for 15 minutes.
Do not move the test cassette. Keep on a flat surface.



WARNING! Do not move or lift the test device during this time.

Step 11. **READ TEST RESULT**

After 15 minutes find result window, labeled as “C” (for Control) and “T” (for Test) on the test cassette. It is important to read your **test result at 15-20 minutes**. DO NOT read after 20 minutes. False negative or false positive results can occur if test results are read before 15 minutes or after 20 minutes.

NOTE: Dispose of the used test in the household trash. Do not flush or pour test liquids down a drain.

In the section below are examples for positive, negative and invalid test results.

8. INTERPRETATION OF THE RESULTS

Test results are read and interpreted visually. Read results at 15 minutes with good lighting.

COVID-19 POSITIVE

If the test cassette looks like the examples below, then protein from the virus that causes COVID-19 was detected in the sample. The test is positive if there are two pink/purple lines present, one at the Control “C” line and one at the Test “T” line. Look very closely for line next to “T”. This line can be very faint. Any visible pink/purple “T” line is a positive result when the “C” line is also present.

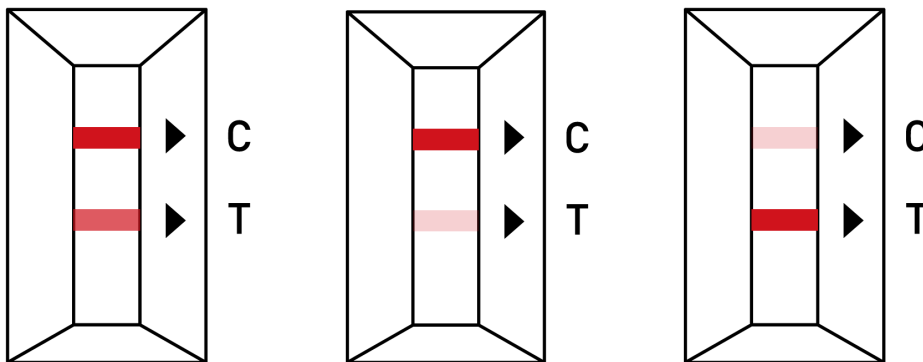

IF THE TEST IS POSITIVE

A Positive test result is interpreted as protein antigen from the virus that causes COVID-19 was detected in the specimen. The individual is positive for COVID-19. Test results should be considered in association with the patient’s history and epidemiological data (such as local prevalence rates and current outbreak/epicenter locations).

Note: The Test line (pink/purple line) may vary in shade and intensity (light or dark, weak or strong) depending on the concentration of antigen present in the sample. The intensity of the Control line should not be compared to that of the Test line for the interpretation of the test result. Any faint visible pink/purple Test line should be interpreted as positive, when the control line (C) line is also present.

COVID-19 NEGATIVE

If the test cassette looks like the example below then protein from the virus that causes COVID-19 was not detected. You will only see one pink/purple line next to “C” and there will not be any line visible next to “T”.

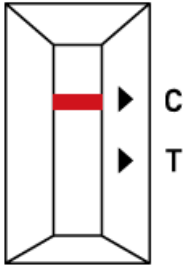

IF THE TEST IS NEGATIVE

A negative test result means that antigen from the virus that causes COVID-19 was not detected in your sample. **Negative results do not rule out SARS-CoV-2 infection. All individuals that test negative should be tested again with at least 24 hours and no more than 48 hours between tests.** All negative results are considered presumptive, and confirmation with a molecular assay, if necessary for patient management, may be performed.

INVALID

If the test cassette looks like the examples below then the test **was not able to give a result** and you must **repeat the test with a new swab, a new tube, and a new test cassette.** The test is INVALID if there is no line next to “C”.

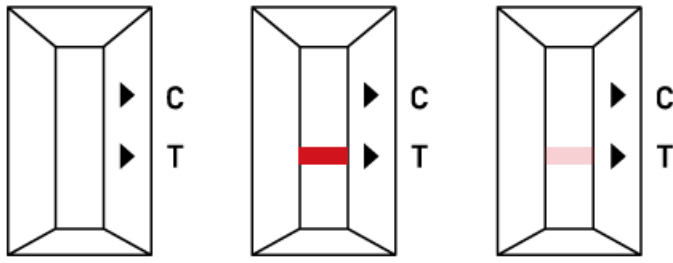

IF THE TEST IS INVALID

If a line does not appear on the control line position (C) in **15 minutes**, the **test result is invalid.** Retest with a new OHC COVID-19 Antigen Self Test.

9. STORAGE AND STABILITY

- OHC COVID-19 Antigen Self Test should be stored between 2 to 30 °C (35.6 to 86 °F).
- Kit components in the OHC COVID-19 Antigen Self Test are stable until the expiration date printed on the label.
- The Test Cassette must remain in the sealed pouch until use.

- Ensure all kit components are at room temperature before use.

10. WARNINGS & PRECAUTIONS

Read the OHC COVID-19 Antigen Self Test Package Insert carefully before performing a test. Failure to follow directions may produce inaccurate test results.

- 1) For in vitro diagnostic use only.
- 2) This product has not been FDA cleared or approved; but has been authorized by FDA under an EUA.
- 3) This product has been authorized only for the detection of proteins from SARS- CoV-2, not for any other viruses or pathogens.
- 4) The emergency use of this product is only authorized for the duration of the declaration that circumstances exist justifying the authorization of emergency use of in vitro diagnostics for detection and/or diagnosis of COVID-19 under Section 564(b)(1) of the Federal Food, Drug and Cosmetic Act, 21 U.S.C. § 360bbb-3(b)(1), unless the declaration is terminated or authorization is revoked sooner.
- 5) Follow directions for use. Operation of this test should not deviate from the provided instructions. If the test instructions are not followed, the test results should NOT be interpreted. The test should then be repeated with a new cassette.
- 6) The Test is intended to aid in the diagnosis of a current COVID-19 infection, not for any other viruses or pathogens. Please consult a healthcare professional to discuss your results and if any additional testing is required.
- 7) Keep test kit and materials out of the reach of children and pets before and after use.
- 8) Use of personal protection materials such as gloves is recommended.
- 9) You should wear a face mask if swabbing others.
- 10) This test is read visually. Users with impaired vision or color-impaired vision may not be able to read the test.
- 11) In the event of spillage, ensure it is cleaned thoroughly with a suitable disinfectant.
- 12) Children aged 2 to 13 years of age should be tested by an adult.
- 13) The control line may show up within a few minutes of starting the test. It may take up to 15 minutes for a test line to show up.
- 14) Do not use on anyone under two years of age.
- 15) Do not open the kit contents until ready for use. If the test cassette is open for an hour or longer, invalid test results may occur.
- 16) Use only the components of this test kit.
- 17) Do not use the test after the expiration date shown on the test cassette pouch.
- 18) Do not use if any of the test kit contents or packaging is damaged or open.
- 19) Do not open the Test Strip pouch packaging until ready to perform a test. Use immediately.
- 20) The test should be performed at ambient temperature (i.e., 15-30°C).
- 21) All kit components are intended for a single use. Do not use more than once. If a test must be repeated, use new components for the retest.
- 22) Laboratories within the United States and its territories are required to report results to the appropriate public health authorities.
- 23) This test is intended as an aid in the diagnosis of COVID-19 by detecting viral antigens but should not be used as a sole criterion for the determination of SARS-CoV-2 infection. Other laboratory tests and clinical information (signs and symptoms) should be used and considered for diagnosis.
- 24) Make sure there is sufficient light when testing. For best results, read test in a well-lit area.
- 25) Do not use nasal sprays for at least 30 minutes before collecting a nasal sample.
- 26) Remove any piercings from the nose before starting the test.
- 27) Do not use on anyone who is prone to nosebleeds or has had facial injuries or head injuries/surgery in the past six months.
- 28) Proper specimen collection and handling are essential for accurate results.
- 29) Do not touch the swab head (specimen collection area) when handling the swab.

- 30) Do not read test results before **15** minutes or after **20** minutes. Results read before **15** minutes or after **20** minutes may lead to a false positive, false negative, or invalid result.
- 31) Do not ingest any kit components.
- 32) Avoid exposure of your skin, eyes, nose, or mouth to the solution in the tube.
- 33) The chemicals in the reagent solution may be hazardous to the skin and eye. Please see the table below for safety recommendations for skin and eye irritation. If the solution contacts the skin or eye, flush with copious amounts of water. If irritation persists, seek medical advice: <https://www.poisonhelp.org> or 1-800-222-1222.

Hazard Category (mixture)	GHS Hazard Class for mixture	Labeling of Harm(s)	Hazardous Ingredients (%)	Recommended PPE Statement
Category 2	Eye Irritation	Causes eye irritation (H320)	Sodium azide/26628-22-8/ (0.05%) Triton X-100/9002-93-1/ (1%) BIS (trimethylsilylacetamide)/ 25561-30-2/1.0% Tris(hydroxymethyl) aminoethane / 77-86-1/1.2%	NA
Category 2	Skin irritation	Causes skin irritation (H315)	Sodium azide/26628-22-8/ (0.05%) Triton X-100/9002-93-1/ (1%) BIS (trimethylsilylacetamide)/ 25561-30-2/1.0% Tris(hydroxymethyl) aminoethane / 77-86-1/ 1.2%	NA

11. LIMITATIONS

- Testing should be performed at least twice over three days, with at least 24 hours and no more than 48 hours between tests. You may need to purchase additional tests to perform this serial (repeat) testing.
- Serial testing (i.e., testing every day or every other day) is more likely to detect COVID-19.
- Do not use this test for individuals under 2 years of age.
- There is a higher chance of false negative results with antigen tests than with laboratory-based molecular tests. This means that there is a higher chance this test will give you a negative result when you have a COVID-19.
- Because it is not possible to know the viral load in a patient's sample prior to molecular testing, serial testing should be performed for all subjects (i.e., both symptomatic and asymptomatic) to increase the likelihood of detecting COVID-19.
- This test is only used for testing direct human anterior nasal swab specimens. Viral transport media (VTM) should not be used with this test.
- The amount of antigen in a sample may decrease as the duration of illness increases. Specimens collected after 7 days are more likely to be negative compared to RT-PCR.
- A negative test result may occur if the level of antigen in a sample is below the detection limit of the test or if the sample was collected improperly.
- The performance of the OHC COVID-19 Antigen SelfTest was evaluated using the procedures provided in these Instructions for Use (IFU) only. Modifications to these procedures may alter the performance of the test.

- Performance of nasal swabs collected from patients with or without symptoms or other epidemiological reasons to suspect COVID-19 infection or for serial screening, when tested twice over three days with at least 24 but not more than 48 hours between tests has not been determined; a study to support use will be completed.
- This test detects both viable (live) and non-viable SARS-CoV-2. Test performance depends on the amount of viral antigen in the sample and may or may not correlate with viral culture results performed on the same sample.
- Test results must be evaluated in conjunction with other clinical data available to the physician.
- Failure to follow the Test Procedure may adversely affect test performance and/or invalidate the test result.
- Positive test results do not rule out co-infections with other pathogens.
- Negative test results are not intended to rule in other non-SARS viral or bacterial infections.
- Negative results do not rule out COVID-19, should be treated as presumptive and may need to be confirmed with an FDA-authorized molecular assay.
- The performance of this test was established based on the evaluation of a limited number of clinical specimens collected in January-February 2022. The clinical performance has not been established in all circulating variants but is anticipated to be reflective of the prevalent variants in circulation at the time and location of the clinical evaluation. Performance at the time of testing may vary depending on the variants circulating, including newly emerging strains of SARS-CoV-2 and their prevalence, which change over time.

12. PERFORMANCE CHARACTERISTICS

a. Analytical Sensitivity: Limit of Detection (LoD)

The Limit of Detection (LoD) of the OHC COVID-19 Antigen Self Test was determined using serial dilutions of heat inactivated SARS-CoV-2 (USA-WA1/202). Contrived samples were prepared by spiking the strain into pooled human nasopharyngeal swab matrix obtained from healthy volunteers confirmed negative by RT-PCR. The preliminary LoD initially determined by testing two-fold serial dilution series of 3 replicates was confirmed by testing in 20 replicates. The confirmed LoD for the OHC COVID-19 Antigen Self Test was 1.40×10^4 TCID₅₀/mL.

The performance of this test device in the detection of the Omicron variant of SARS-CoV-2 was evaluated in a dilution series of clinical specimens which were positive for the Omicron variant. This testing was conducted by the National Institutes of Health (NIH) as a component of the Rapid Acceleration of Diagnostics (RADx[®]) initiative. The clinical specimens used to prepare this dilution series were not identical to the previous specimen pools prepared and tested by RADx to assess performance with the omicron variant. Results from this dilution series cannot be compared to other specimen pools and do not indicate that a test will have different clinical performance compared to other EUA authorized tests. Compared to an EUA authorized RT-PCR method, the OHC COVID-19 Antigen Self Test detected 100% of live virus Omicron samples at a Ct-value of 23.6 (n=5). Testing was also compared to two additional EUA-authorized OTC antigen tests (Assay #1 and Assay #2). Omicron dilutions at lower viral concentrations (Ct-values greater than 24.0) were not detected by the OHC COVID-19 Antigen Self Test in this study.

Omicron Pool 2 – Live Omicron Clinical Samples	Average N2 Ct (n=9)	Assay #1 Percent Positive (n=5)	Assay #2 Percent Positive (n=5)	OHC COVID-19 Antigen Self Test Percent Positive (n=5)
Omicron-Dilution 1	19.8	100	100	100
Omicron-Dilution 2	20.8	100	100	100
Omicron-Dilution 3	21.5	100	100	100

Omicron Pool 2 – Live Omicron Clinical Samples	Average N2 Ct (n=9)	Assay #1 Percent Positive (n=5)	Assay #2 Percent Positive (n=5)	OHC COVID-19 Antigen Self Test Percent Positive (n=5)
Omicron-Dilution 4	22.7	100	100	100
Omicron-Dilution 5	23.6	100	0	100
Omicron-Dilution 6	24.0	60	0	0
Omicron-Dilution 7	24.8	0	0	0
Omicron-Dilution 8	25.8	0	0	0
Omicron-Dilution 9	27.4	0	0	0
Omicron-Dilution 10	28.1	0	0	0
Omicron-Dilution 11	29.1	0	0	0

b. High-dose hook effect

The OHC COVID-19 Antigen Self Test was tested up to 2.86×10^6 TCID₅₀/mL heat inactivated SARS-CoV-2 (USA-WA1/2020) and no high-dose hook effect was observed.

c. Endogenous Interfering Substances

The OHC COVID-19 Antigen Self Test was evaluated for performance in the presence of potentially interfering substances that might be present in a respiratory specimen. The positive (3X LoD SARS-CoV-2) and negative specimens were tested with the addition of potentially interfering substances. The performance of the OHC COVID-19 Antigen Self Test was not affected by any of the potentially interfering substances listed in the table below at the concentrations tested.

Substance	Concentration
Whole blood	4% v/v
NasoGEL (NeilMed)	5% v/v
Phenylephrine (Nasal Drop)	15% v/v
Mucin (porcine stomach type II)	0.5%
Oxymetazoline (Nasal Spray)	15% v/v
Tobramycin	4 µg/ml
Body & Hand Lotion	0.5% w/v
Hand Lotion	5% w/v
Hand Sanitizer with Aloe, 62% ethyl alcohol	5% v/v
Hand Sanitizer 80% ethanol, fast drying	15% v/v

Substance	Concentration
Homeopathic (Alkalol)	10% v/v
Oseltamivir phosphate (Tamiflu)	5 mg/mL
Cromolyn (Nasal Spray)	15% v/v
Chloraseptic (Menthol/Benzocaine)	1.5 mg/mL
Zicam	5% v/v
Sore Throat Phenol Spray	15% v/v
Mupirocin	10 mg/mL
Fluticasone Propionate	5% v/v
Hand soap liquid gel	10% w/v
Hand Sanitizer cream lotion	15% v/v

Substance	Concentration
Body Lotion with 1.2% dimethicone	0.5% w/v

Substance	Concentration

d. Analytical Specificity: Cross-reactivity and Microbial Interference

Cross reactivity and interference studies were performed for related pathogens, high prevalence disease agents, and normal or pathogenic flora that are reasonably likely to be encountered in the clinical specimens of the nasal cavity. Each organism and virus (13 bacteria and 16 viruses) were tested in both absence and presence of inactivated SARS-CoV-2 (SARS-CoV-2 isolate USA-WA1/2020) at the 3X LoD. All testing samples were prepared in the negative clinical nasal wash. No cross reactivity or interference was observed for any of the organisms tested, except for SARS-coronavirus which exhibited cross-reactivity when tested as 7.90×10^3 TCID₅₀/mL. A titration of SARS-CoV was performed to find the concentration at which cross-reactivity was no longer observed. Cross reactivity was no longer observed for SARS-CoV at 7.90×10^0 TCID₅₀/mL. These results are not unexpected in that the OHC COVID-19 Antigen Self Test targets the nucleocapsid protein which is present on both SARS-CoV and SARS-CoV-2 viruses.

ID	Organism	Concentration Tested for Cross Reactivity	Concentration Tested for Microbial Interference
229E	Human coronavirus 229E	1.43×10^5 TCID ₅₀ /mL	1.43×10^5 TCID ₅₀ /mL
OC43	Human coronavirus OC43	1.43×10^5 TCID ₅₀ /mL	1.43×10^5 TCID ₅₀ /mL
NL63	Human coronavirus NL63	1.43×10^5 TCID ₅₀ /mL	1.43×10^5 TCID ₅₀ /mL
SARS	SARS-coronavirus		
MERS	MERS-coronavirus	1.0×10^6 TCID ₅₀ /mL	1.0×10^6 TCID ₅₀ /mL
AV1	Adenovirus (e.g. C1 Ad. 71)	1.43×10^5 TCID ₅₀ /mL	1.43×10^5 TCID ₅₀ /mL
hMPV	Human metapneumovirus (hMPV)	1.43×10^5 TCID ₅₀ /mL	1.43×10^5 TCID ₅₀ /mL
P1	Parainfluenza virus 1	1.43×10^5 TCID ₅₀ /mL	1.43×10^5 TCID ₅₀ /mL
P2	Parainfluenza virus 2	1.43×10^5 TCID ₅₀ /mL	1.43×10^5 TCID ₅₀ /mL
P3	Parainfluenza virus 3	1.43×10^5 TCID ₅₀ /mL	1.43×10^5 TCID ₅₀ /mL
P4	Parainfluenza virus 4b	1.43×10^5 TCID ₅₀ /mL	1.43×10^5 TCID ₅₀ /mL
FluA	Influenza A	1.43×10^5 CEID ₅₀ /mL	1.43×10^5 CEID ₅₀ /mL
FluB	Influenza B	1.43×10^5 CEID ₅₀ /mL	1.43×10^5 TCID ₅₀ /mL
EV68	Enterovirus 68	1.43×10^5 TCID ₅₀ /mL	1.43×10^5 TCID ₅₀ /mL
RSV	Respiratory syncytial virus	1.0×10^5 PFU/mL	1.0×10^5 pfu/mL
RV	Rhinovirus	1.43×10^5 TCID ₅₀ /mL	1.43×10^5 TCID ₅₀ /mL
HI	<i>Haemophilus influenzae</i>	1.0×10^6 cfu/vial	1.00×10^6 cfu/mL
SPN	<i>Streptococcus pneumoniae</i>	1.0×10^6 cfu/mL	1.0×10^4 cfu/mL
SPY	<i>Streptococcus pyogenes</i>	1.0×10^6 cfu/vial	1.0×10^6 cfu/mL
CA	<i>Candida albicans</i>	1.0×10^6 cfu/vial	1.0×10^6 cfu/mL
BP	<i>Bordetella pertussis</i>	1.0×10^6 cfu/vial	1.0×10^6 cfu/mL
MP	<i>Mycoplasma pneumoniae</i>	1.0×10^6 cfu/vial	1.0×10^6 cfu/mL
CP	<i>Chlamydia pneumoniae</i>	1.0×10^6 IFU/mL	1×10^6 IFU/mL
LP	<i>Legionella pneumophila</i>	1.0×10^6 cfu/mL	1.0×10^6 cfu/mL
MT	<i>Mycobacterium tuberculosis</i>	1.0×10^6 cfu/mL	1.0×10^6 cfu/mL
PC	<i>Pneumocystis carinii</i>	1.00×10^6 cfu/mL	1.0×10^6 cfu/mL
PJ	<i>Pneumocystis jirovecii</i> -S. cerevisiae (recombinant)	1.0×10^6 cfu/mL	1.0×10^6 cfu/mL
SA	<i>Staphylococcus aureus</i> subsp. aureus	1.0×10^6 cfu/vial	1×10^6 cfu/mL

ID	Organism	Concentration Tested for Cross Reactivity	Concentration Tested for Microbial Interference
SE	<i>Staphylococcus epidermidis</i>	2.33 x 10 ⁵ cfu/vial	2.33 x 10 ⁵ cfu/mL
PNW	Pooled Negative Nasal Wash	N/A	N/A

To estimate the likelihood of cross reactivity with SARS-CoV-2 of organisms that were not available for wet testing, *in-silico* analysis using the Basic Local Alignment Search Tool (BLAST) managed by the National Center for Biotechnology Information (NCBI) was used to assess the degree of protein sequence homology. HKU1 nucleocapsid phosphoproteins was analyzed and the results are below.

- The homology between SARS-CoV-2 nucleocapsid protein and human coronavirus HKU1 nucleocapsid phosphoproteins is relatively low, 36.7% across 82% of sequences, but cross-reactivity cannot be ruled out.

e. Flex Study

A robust use of OHC COVID-19 Antigen Self Test was demonstrated by seven (7) flex studies as follows:

- 1) Delay in reading results study
- 2) Disturbance while testing study
- 3) Mixing study
- 4) Non-level surface testing study
- 5) Sample volume variability study
- 6) Lighting
- 7) Temperature and Humidity

13. CLINICAL EVALUATION

A prospective study was completed at six (6) sites in the United States for clinical validation of the OHC COVID-19 Antigen Self Test for the detection of the SARS-CoV-2 in subject-collected anterior nasal (AN) swab samples. The study evaluated the investigational test's performance in symptomatic individuals (those suspected of COVID-19). A total of 259 symptomatic subjects were enrolled and each were currently experiencing symptoms associated with COVID-19, **within 7 days of symptom onset**. Each enrolled subject either self-collected one sample from their anterior nasal passages (from both nostrils), or had one sample collected from him/her by another individual. Each subject then had a mid-turbinate sample (from both nostrils) collected from him/her by one of the study personnel. Test results from the OHC COVID-19 Antigen Self Test (candidate test) were compared to highly sensitive molecular FDA EUA Authorized SARS-CoV-2 assays to determine test performance. An analysis was performed which identified that 41/120 (34%) of study subjects had low viral loads based on the Ct values from a comparator method RT-PCR test. This may be associated with the Omicron variant since the low positive percentage in this study is higher than that observed in prior clinical studies for previously authorized COVID-19 rapid antigen tests. Antigen test performance decreases as the percent of low positives increases since the comparator method is significantly more sensitive than the candidate test. Therefore, to be consistent with previous studies, the analysis for the primary performance calculation was conducted to reflect a study population with 10-20% low positives. Multiple Percent Positive Agreement (PPA) calculations are presented below for the positive sample cohort when a range of low positive samples was included (10% to 20%). At 10% low positives the PPA was 82.9% and the negative percent agreement (NPA) was 98.6% with 95% confidence interval bounds of 73.8% to 89.4% PPA and 94.9% to 99.6% for NPA respectively. This was the basis of the authorization. At 20% low positives, the PPA was 73.7% with 95% confidence interval bounds of 64.3% to 81.4%.

Primary Analysis					
	10% Low Positives	12.5% Low Positives	15% Low Positives	17.5% Low Positives	20% Low Positives
High Positive Samples	79	79	79	79	79
Low Positive Samples	9	12	14	17	20
Total Comparator Positives for PPA Calculation	88	91	93	96	99
Total Device Positives for PPA Calculation	73	73	73	73	73
PPA (%)	82.9 (73/88)	80.2 (73/91)	78.5 (73/93)	76.0 (73/96)	73.7 (73/99)
95% CI (XX% - XX%)	73.8-89.4	70.9-87.1	69.1-85.6	66.6-83.5	64.3-81.4
NPA (%)	98.6 (137/139)				
95% CI (XX% - XX%)	94.4-99.6				

When all study participants are included, the PPA is 64.2% and the negative percent agreement is 98.6% with the 95% confidence interval bounds of 55.3% to 72.2% for the PPA and 94.9% to 99.6% for the NPA, respectively.

Age and Gender Distribution and positive Rate of Symptomatic Subjects Within First 7 Days of Symptom Onset				
Subject Age	Female	Male	Positives	% Positivity Rate
<14 years of age	20	21	11	26.8%
14-24 years of age	18	10	10	35.7%
>24-64 years of age	100	71	88	51.5%
=>65 years of age	13	6	11	57.9%
Total	151	108	120	46.3%

Positive Results Broken Down by Days Since Symptom Onset				
Days Post Symptom Onset	Number of Samples tested	OHC COVID-19 Antigen Self Test Positives	RT-PCR Positives	PPA
0	15	6	8	75.0%
1	63	13	27	48.1%
2	84	25	38	63.2%
3	57	19	26	73.1%
4	17	8	10	70.0%
5	11	4	5	80.0%
6	9	4	5	80.0%
7	3	0	1	0.0%
Total	259	79	120	64.2%

14. TECHNICAL SUPPORT

For questions, or to report a problem, please call TechnicalSupport at 844-760-0556 (Available Hours: Mon. to Fri.: 9 a.m. – 5 p.m. PST) or covidhometest@osangllc.com.













Test system problems may also be reported to the FDA using the MedWatch reporting system (phone: 1-800 FDA-1088; fax: 1-800 FDA-1078; or <http://www.fda.gov/medwatch>).

15. ORDERING AND CONTACT INFORMATION

OSANG LLC
215 N. Marengo Ave. 3rd Floor
Pasadena, CA 91101
covidhometest@osangllc.com
www.osanghc.com/en/ifu/hometest/

16. INTERNATIONALSYMBOL USAGE

You may see one or more of these symbols on the labelling/packaging of this product:

	Use-by date		Batch Code		<i>In vitro</i> diagnostic device
	Reference number		Consult instructions for use		Manufacturer
	Contains sufficient for <n> test		Temperature limit		Do not reuse
	Caution		Do not use if the packaging is damaged		Date of manufacture